





Brzo,
jednostavno,
pouzđano...
jednim potezom





DINAGENT



Beograd, Save Maškovića 3-5
Tel./faks: 011 / 397-39-39
office@dinagent.com
www.dinagent.com

Brzo rastavljiva spojnica, ženski deo

Tip	Dimenzije	din.
191 	1/4	820
	3/8	880
	1/2	955
111 mignon	1/8 mign.	510
	1/4 mign.	510
192 	1/4	910
	3/8	925
	1/2	955
112 mignon	1/8 mign.	510
	1/4 mign.	510
195 	6 mm	925
	8 mm	955
	10 mm	1.005
	12 mm	1.005
115 mignon	6 mign.	485
196, 14A1U 	6/14 mm	925
	8/15 mm	955
	8/17 mm	1.075
	10/17 mm	1.155

Brzo rastavljiva spojnica, muški deo

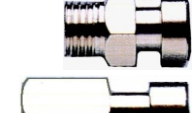
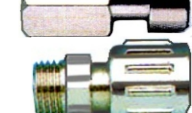

261 	1/4	230
	3/8	250
	1/2	290
211 mignon	1/8 mign.	150
	1/4 mign.	165
262 	1/4	240
	3/8	290
	1/2	410
212 mignon	1/8 mign.	150
	1/4 mign.	165
265 	6 mm	215
	8 mm	275
	10 mm	290
	12 mm	410
215 mignon	6 mignon	130
266 	6/14 mm	270
	8/15 mm	280
	8/17 mm	430
	10/17 mm	535

Tip	Dimenzije	din.
8F 	7 i 8 mm	150
	10 mm	180
	12 i 14 mm	280
7 	1/4	180
8 	1/4	185
9A 	1/4	180









Brza spojnica sa spiralom, ženska Tip 193	Dim.	din.
	6/4	1.025
	8/6	1.075
	10/8	1.075
	10/6,5	1.075
	12/10	1.155

Brza spojnica sa spiralom, muška Tip 263	Dim.	din.
	6/4	390
	8/6	430
	10/8	455
	12/10	515

Tip	Dimenzije	din.
1855, 38A1 	6/4	660
	8/6	675
	10/8	725
	12/10	825
1026 	6/4 - 1/4	615
	8/6 - 1/4	665
	10/6,5 - 1/4	715
	10/8 - 1/4	715
	12/8 - 3/8	715

Konusni priključci sa holenderom

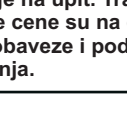
Tip	Dimenzije	din.
1000 	4/2,7-M5	135
	4/2,7-1/8	135
	6/4-1/8	140
	6/4-1/4	150
	8/6-1/8	155
	8/6-1/4	180
	8/6-3/8	190
	10/8-1/8	180
	10/8-1/4	185
	10/8-3/8	210
	10/8-1/2	245
12/10-1/2	315	
1110 	4/2,7-1/8	220
	6/4-1/8	220
	6/4-1/4	240
	8/6-1/8	260
	8/6-1/4	280
	8/6-3/8	465
1130 	10/8-1/4	310
	10/8-3/8	485
1130 	6/4	215
	8/6	245
	10/8	315
1230 	6/4	270
	8/6	315
	10/8	395
1040 	6/4	260
	8/6	285
	10/8	340
	12/10	360
15/12,5	470	
1300 	6/4	390
	8/6	460
	10/8	575

Priključci za gumena creva

Tip 3040	Dimenzije	din.
	6-1/8	165
	6-1/4	185
	7-1/8	165
	7-1/4	185
	8-1/8	200
	8-1/4	205
	9-1/4	205
	9-3/8	265
	9-1/2	265
	10-1/4	205
	10-3/8	240
	10-1/2	265
	12-3/8	240
	12-1/2	275
	14-3/8	280
	14-1/2	315
17-1/2	320	
20-3/4	430	

Tip 9F	Dimenzije	din.
	6 mm	200
	8 mm	210
	10 mm	220
	12 mm	245

- ❖ VP cene (bez PDV), fco skladište u Beogradu.
- ❖ Prikazani su tipični predstavnici. Ostali tipovi i dimenzije na upit. Tražite detaljnu ponudu.
- ❖ Navedene cene su na današnji dan, ne stvaraju nikakve obaveze i podložne su promeni bez obaveštenja.

Beograd, jan. 2023

Brzi priključak Tip 50000	Dimenzije	din.
	3-M5	210
4-M5	145	
4-1/8	150	
4-1/4	155	
5-M5	185	
5-1/8	160	
5-1/4	165	
6-M5	150	
6-1/8	155	
6-1/4	160	
6-3/8	170	
6-1/2	255	
8-1/8	170	
8-1/4	185	
8-3/8	210	
8-1/2	265	
10-1/4	260	
10-3/8	265	
10-1/2	330	
12-1/4	330	
12-3/8	335	
12-1/2	400	
14-3/8	380	
14-1/2	420	
16-1/2	535	

Prolazni nastavak Tip 50050	Dimenzije	din.
	Ø 4	340
Ø 6	400	
Ø 8	420	
Ø 10	495	
Ø 12	625	

Nastavak Tip 50040 - metalni	Dimenzije	din.
	Ø 3	255
Ø 4	270	
Ø 5	280	
Ø 6	285	
Ø 6-4	285	
Ø 8	340	
Ø 8-6	335	
Ø 10	420	
Ø 10-8	415	
Ø 12	495	
Ø 12-10	490	
Ø 14	800	
Ø 16	1.075	

Nastavak Tip 55040 - plastični	Dimenzije	din.
	Ø 4	240
Ø 5	285	
Ø 6	245	
Ø 8	285	
Ø 8-4	285	
Ø 8-6	285	
Ø 10	340	
Ø 10-6	350	
Ø 10-8	350	
Ø 12	400	
Ø 12-8	400	
Ø 12-10	430	
Ø 14	640	

REDUKCIJA Tip 50700 - smanjenje	Dimenzije	din.
	6-4	195
8-4	205	
8-6	210	
10-4	265	
10-6	265	
10-8	265	
12-8	285	
12-10	310	

Tip 55705 - povećanje	Dimenzije	din.
	4-6	210
6-8	225	
8-10	255	
10-12	260	

Slepi priključak Tip 55620	Dimenzije	din.
	Ø 4	130
Ø 6	140	
Ø 8	145	
Ø 10	155	
Ø 12	165	
Ø 14	190	

Brzi priključak Tip 50030	Dimenzije	din.
	4-1/8	230
4-1/4	330	
6-1/8	230	
6-1/4	245	
8-1/8	255	
8-1/4	265	
8-3/8	310	
10-1/4	285	
10-3/8	330	
10-1/2	360	
12-3/8	380	
12-1/2	420	

Koleno, produženo Tip 50121	Dimenzije	din.
	6-1/8	350
6-1/4	365	
8-1/8	385	
8-1/4	445	

Obrtni priključak Tip 51410	Dimenzije	din.
	M5	110
1/8	140	
1/4	160	

Tip 51420	Dimenzije	din.
	1/8	165
1/4	210	

Bendžo Tip 50500	Dimenzije	din.
	4-M6	245
6-M6	255	
4-1/8	310	
6-1/8	230	
6-1/4	245	
8-1/8	265	
8-1/4	265	
8-3/8	310	
10-1/4	310	
10-3/8	335	
12-1/2	400	

Dvostrani bendžo Tip 50510	Dimenzije	din.
	6-1/8	335
8-1/4	375	

T-Komad, bočni Tip 50222	Dimenzije	din.
	6-1/8	445
6-1/4	515	
8-1/8	525	
8-1/4	535	
10-1/4	690	

Čep za priključke Tip 50610	Dimenzije	din.
	Ø 4	65
Ø 6	65	
Ø 8	70	
Ø 10	75	
Ø 12	90	
Ø 14	95	

X-račva Tip 55330 plastična	Dimenzije	din.
	Ø 6	855
Ø 8-6	855	









Koleno Tip 50130 - metalno Tip 55130 - plastično	Dimenzije	din.	
		Metalno	Plastično
Ø 4 mm	255	240	
Ø 5 mm	260	/	
Ø 6 mm	265	255	
Ø 8 mm	310	275	
Ø 10 mm	400	380	
Ø 12 mm	550	495	
Ø 14 mm	840	690	

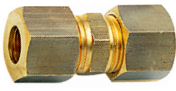

Koleno sa navojem Tip 50111 - metalno	Dimenzije	din.	
		Metalno	Plastično
4-M5	280	/	
4-1/8	280	245	
4-1/4	290	265	
5-1/8	295	265	
6-M5	290	/	
6-1/8	295	270	
6-1/4	310	280	
6-3/8	/	310	
6-1/2	/	380	
8-1/8	330	310	
8-1/4	360	345	
8-3/8	435	/	
8-1/2	450	385	
10-1/4	460	/	
10-3/8	495	/	
10-1/2	560	490	
12-1/4	575	/	
12-3/8	605	/	
12-1/2	665	/	
14-3/8	690	/	
14-1/2	800	/	
16-1/2	935	/	

T-komad Tip 50230 - metalni Tip 55230 - plastični	Dimenzije	din.	
		Metalni	Plastični
Ø 3	350	/	
Ø 4	365	335	
Ø 5	395	345	
Ø 6 4 6	/	360	
Ø 6	420	360	
Ø 8 6 8	/	420	
Ø 8	455	420	
Ø 8 10 8	/	420	
Ø 10 8 10	/	570	
Ø 10	660	585	
Ø 12 10 12	/	705	
Ø 12	860	715	
Ø 14	1.240	920	

T-komad sa navojem Tip 50211 - metalni Tip 55210 i 55216 plastični	Dimenzije	din.	
		Metalni	Plastični
4-1/8	445	350	
4-1/4	445	395	
5-1/8	445	385	
6-M5	/	400	
6-1/8	445	/	
6-1/4	475	405	
8-1/8	515	450	
8-1/4	515	/	
8-3/8	630	535	
8-1/2	/	570	
10-1/4	690	595	
10-3/8	715	640	
10-1/2	740	670	
12-1/4	/	685	
12-3/8	695	695	
12-1/2	785	700	
14-3/8	1.060	1.005	
14-1/2	1.190	1.070	

Račva Tip 50310 metalna Tip 55310 plastična	Dimenzije	din.	
		Metalna	Plastična
Ø 4	545	475	
Ø 6-4	/	530	
Ø 6	560	530	
Ø 8-6	/	570	
Ø 8	670	585	
Ø 10-8	/	590	
Ø 10	690	590	
Ø 12	/	635	

Priključci za metalne cevi sa usečnim prstenom		
Tip	Dimenzije	din.
13480 - priključak 	4-1/8	140
	6-1/8	160
	6-1/4	165
	8-1/8	180
	8-1/4	185
	10-1/4	230
	10-3/8	275
	10-1/2	320
	12-3/8	315
	12-1/2	360
13280 - koleno 	4-1/8	165
	6-1/8	195
	6-1/4	200
	8-1/8	220
	8-1/4	225
	10-1/4	270
	10-3/8	275
	10-1/2	320
	12-1/4	335
	12-3/8	380
12-1/2	415	
13460 - nastavak 	4 mm	165
	6 mm	200
	8 mm	210
	10 mm	285
	12 mm	340
13260 - koleno 	4 mm	200
	6 mm	220
	8 mm	245
	10 mm	335
	12 mm	425
	14 mm	530
13200 - T komad 	4 mm	265
	6 mm	295
	8 mm	340
	10 mm	495
	12 mm	660
	14 mm	790
13220 - T komad 	6 -1/8	240
	6 -1/4	245
	8 -1/4	265
	10 -1/4	395
	10 -3/8	425
	10 -1/2	460
	12 -1/2	920
13530 - adapter 	6 -1/8	145
	6 -1/4	165
	8 -1/8	150
	8 -1/4	185
	10 -1/4	220
	10 -3/8	265
	14 -1/2	425
13600 - redukcija 	4 - 6	150
	6 - 8	165
	8 - 10	250
	10 - 12	280



Tip	13740	10770	13680
Izgled			
4,6 i 8 mm	40	45	50
10, 12, 14 mm	55	60	80

Trodelni nipl 	Dimenzije		din.
	1/8		215
	1/4		250
	3/8		315
Tip 2060			



Četvorostrani razvodni blok Tip 6040			
Dimenzije	1/4	3/8	1/2
din.	325	455	555
			

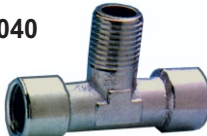





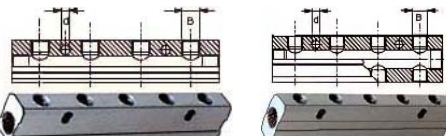

Tip	Koleno	Dimenzije	din.
5000 		1/8	215
		1/4	285
		3/8	465
		1/2	565
		3/4	660
		1	785
5010 		1/8	215
		1/4	285
		3/8	465
		1/2	565
		3/4	660
		1	785
Fiksno koleno, 5050 		1/2	605
5020 		1/8	215
		1/4	285
		3/8	465
		1/2	565
		3/4	660
		1	785

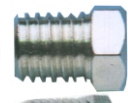
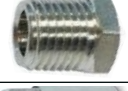
Tip	T-komad	Dimenzije	din.
4000 		1/8	310
		1/4	340
		3/8	425
		1/2	605
		3/4	715
		1	1.025
4020 		1/8	310
		1/4	340
		3/8	425
		1/2	605
		3/4	715
		1	1.025
4040 		1/8	310
		1/4	340
		3/8	425
		1/2	605
		3/4	715
		1	1.025
4050 		1/8	310
		1/4	340
		3/8	425
		1/2	605
		3/4	715
		1	1.025
Y-račva 6000-M 6010-F 		1/8	355
		1/4	455
		3/8	500
		1/2	600

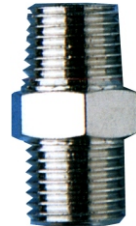
Krst 6020 	Dimenzije		din.
	1/8		320
	1/4		455
	3/8		555
	1/2		715

Krst 6025 	Dimenzije		din.
	1/8		320
	1/4		455
	3/8		555
	1/2		715

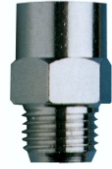
Razvodni blokovi, tip:			
6047 - jednostrani		6048 - obostrani	
			
Dimenzije	din.	Dimenzije	din.
2x1/4-2x1/8	875	2x1/4-2x2x1/8	875
2x1/4-4x1/8	1.550	2x3/8-2x2x1/4	955
2x1/4-6x1/8	1.790	2x1/2-2x2x3/8	1.550
2x3/8-4x1/4	1.655		
2x3/8-6x1/4	1.990		
2x1/2-4x3/8	1.740		

Tip	Dimenzije	din.	
3015 sa zaptivkom 	M5	150	
	1/8	155	
	1/4	205	
	3/8	240	
	1/2	295	
3/4	360		
3020 paralelni 	M5	130	
	1/8	135	
	1/4	195	
	3/8	205	
3021 konusni 	1/2	240	
	3/4	290	
	1	320	
3030 slepi 	1/8	185	
	1/4	205	
	3/8	260	
	1/2	340	
2000 dupli nipl 	M5-M5	140	
	1/8-1/8	125	
	1/4-1/4	150	
	3/8-3/8	195	
	1/2-1/2	275	
	3/4-3/4	350	
	1-1	530	
	2020 nipl, reducir 	M5-1/8	135
		1/8-1/4	155
		1/8-3/8	185
1/8-1/2		265	
1/4-3/8		180	
1/4-1/2		265	
3/8-1/2		275	
1/2-3/4		460	
3/4-1		590	
1		590	
3000 muf 	1/8-1/8	135	
	1/4-1/4	150	
	3/8-3/8	185	
	1/2-1/2	275	
	3/4-3/4	445	
	1-1	530	
	3010 muf reducir 	M5-1/8	145
		1/8-1/4	140
		1/8-3/8	180
		1/8-1/2	210
1/4-3/8		170	
1/4-1/2		260	
3/8-1/2		270	
1/2-3/4		490	
1-1/2		595	
1-3/4		765	
2080, 2090 reducir 	M5-1/8	155	
	1/8-1/4	150	
	1/8-3/8	170	
	1/8-1/2	210	
	1/4-3/8	180	
	1/4-1/2	255	
	3/8-1/2	275	
	1/2-3/4	315	
	1-1/2	390	
	1-3/4	415	
2040, 2050 nastavak reducir 	M5-1/8	155	
	1/8-1/4	150	
	1/8-3/8	170	
	1/4-1/4	185	
	1/4-3/8	180	
	1/4-1/2	260	
	3/8-1/2	275	
1/2-1/2	360		
1/2-3/4	390		
2070 produžni nastavak 	1/4x51mm	285	
3060 prodor 	1/8-M16x1,5	225	
	1/4-M20x1,5	245	
	3/8-M26x1,5	280	
	1/2-M28x1,5	460	



	Dimenzije	din.
	1/8-1/8	515
	1/4-1/4	560
	3/8-3/8	610
	1/2-1/2	710
3/4-3/4	1.100	

	Dimenzije	din.
	1/8-1/8	515
	1/4-1/4	560
	3/8-3/8	610
	1/2-1/2	710
3/4-3/4	1.100	

	Crevo Ø	din.
	4 mm	790
	6 mm	810
	8 mm	920
	10 mm	1.055
12 mm	1.130	

	Dimenzije	din.
	1/2	950
	3/4	1.205
	1	1.910

	Dimenzije	Cena
	1/2	950
	3/4	1.205
	1	1.910

	
	
<p>Ugradna trokraka slavina 1/4" 1.100 din.</p>	

	Dimenzije	din.
	1/8	1.075
	1/4	1.270
	1/2	1.845

	Dimenzije	Cena
	1/8	520
	1/4	640
	3/8	800
	1/2	1.160

	Dimenzije	Cena
	4-M6	245
	6-M6	255
	4-1/8	295
	6-1/8	230
	6-1/4	245
	8-1/8	265
	8-1/4	265
	8-3/8	310
	10-1/4	310
	10-3/8	335
12-1/2	400	





Ventili za regulaciju brzine cilindra	Dimenzije	din.
8900, 8905, 8920: Prigušno-nepovratni	M5	665
8910, 8915, 8925: Prigušni	1/8	590
	1/4	635
	3/8	1.030
	1/2	1.340





Ugradna ugaona slavina 1/4" Tip 6720 	995 din.
--	----------

Y-filter tip 6035 	<table border="1"> <tr> <td>Dim.</td> <td>1/2</td> <td>3/4</td> <td>1</td> <td>2</td> </tr> <tr> <td>din.</td> <td>715</td> <td>1.075</td> <td>1.720</td> <td>5.590</td> </tr> </table>	Dim.	1/2	3/4	1	2	din.	715	1.075	1.720	5.590
Dim.	1/2	3/4	1	2							
din.	715	1.075	1.720	5.590							

Nepovratni ventili	Dimenzije	din.
Tip 6062 	M5	575
	1/8	575
	1/4	730
6063 	3/8	1.580
	1/2	1.665
6064 	Ø 4	575
	Ø 6	675
	Ø 8	745
6036 	1/2	635
	3/4	1.070
	1	1.115
	2	3.085

Prigušnici buke	Dimenzije	din.
Tip 7000 	1/8	135
	1/4	180
	3/8	210
	1/2	330
7010 	1/8	190
	1/4	285
	3/8	345
	1/2	480
7030 	M 5	245
	1/8	230
	1/4	315
	3/8	445
7050 	1/8	475
	1/4	490
	3/8	695
	1/2	745
7070 - plastika 	1/8	160
	1/4	200
	3/8	365
	1/2	365

Tip	Dimenzije	din.
8850 	M5	790
	1/8	895
	1/4	1.165
	3/8	2.100
8860 	1/2	2.490
55940 	Ø 4	705
	Ø 6	895
	Ø 8	1.280
	Ø 10	1.285

Pritisni prekidač			
Tip	31	32	
Funkcija	NO	NZ	
Dimenzije	1/8 i 1/4		
din. 3.985			



PRIPREMNE GRUPE		
Velicina	Dimenzije	din.

FILTERREGULATOR			
MINI	1/4	2.840	
1	1/8 1/4 3/8	5.330	
2	1/4 1/2 3/8	6.910	
3	1/2 3/4 1	13.605	



NAULJIVAČ			
MINI	1/4	2.475	
1	1/8 1/4 3/8	3.775	
2	1/4 1/2 3/8	4.750	
3	1/2 3/4 1	9.885	



FILTER			
MINI	1/4	2.370	
1	1/8 1/4 3/8	3.595	
2	1/4 1/2 3/8	4.495	
3	1/2 3/4 1	9.115	



REGULATOR			
MINI	1/8 1/4	1.725	
1	1/8 1/4 3/8	3.640	
2	1/4 1/2 3/8	5.115	
3	1/2 3/4 1	10.575	







2-delna PRIPREMNA GRUPA			
MINI	1/4	5.630	
1	1/8 1/4 3/8	7.620	
2	1/4 1/2 3/8	9.930	
3	1/2 3/4 1	21.360	



3-delna PRIPREMNA GRUPA			
MINI	1/4	7.200	
1	1/8 1/4 3/8	8.040	
2	1/4 1/2 3/8	10.900	
3	1/2 3/4 1	25.315	



Aksijalni	Manometar			Radijalni
	Ø 40	50	63	
	din. 820 960 1.010			

Ugradni manometri Ø 40 mm		
	din.	
	1.855	

Blokada klipnjače			
Tip	8880	8890	
Funkcija	jednosm.	dvosmer.	
Dimenzije	1/8	1/4	
Cena din.	3.940	4.475	

